

( ) ,

INTERSTATE COUNCIL FOR STANDARDIZATION. METROLOGY AND CERTIFICATION  
(ISC)

**12.1.019—  
2017**

12.1.019—2017

1.0—2015 «  
 1.2—2015 «  
 1  
 2 251 «  
 3  
 ( 30 2017 . N? 52)  
 :

( 3160) 004—97	( 3166) 004-97	
	AM BY KG RU TJ UZ	

4 2018 . No 941- 12.1.019—2017 7  
 1 2019 .  
 5

« « », ( )  
 « ».  
 (www.gost.ru)

© . 2018



II

1	.....	1
2	.....	1
3	.....	1
4	.....	2
4.1	.....	2
4.2	.....	4
4.3	.....	6
( )	.....	7
( )	.....	8
8 ( )	.....	9
( )	.....	14
	.....	16

12.1.019—2017

[1]—{3J.

**Occupational safety standards system. Electrical safety.  
General requirements and nomenclature of types of protection**

— 2019—01—01

1

, , , ,  
, .  
.

2

8

:

- 12.2.007.0—75 . . -
- 12.2.009—2017 . . -
- IEC 61140—2012 . -
- IEC 60519-1 —2011 . 1. -

— — -  
-  
-

« » , « » 1 , ( -  
) ( ), , ( ,  
8 , . , ,

3

8

12.1.009—2017. -

3.1

: : , -

12.1.019—2017

3.2

(insulation):

( IEC 60519-1—2011. 3.2.5)

3.3

( ): -

3.4

( ) ( ): , 50

120

3.5

( ) (SELV system): -

.

-

>

.

( IEC 61140—2012. 3.26.1]

3.6

( ) (PELV system): -

.

-

-

.

( IEC 61140—2012. 3.26.2]

3.7

(PEN-200 )

3.8

(simple separation):

[ IEC 61140—2012. 3.23]

4

4.1

4.1.1

4.1.2

:

-

-

;

«

;

-

:

-

-

4.1.3

4.1.4

1

2

4.1.5

4.1.6

4.1.7

4.1.8

4.1.9



1 2.5 1000 1500 , , -  
2 , , -  
3 . -  
4 . -  
4.2.2 :  
- :  
> :  
- ;  
• .  
— .  
: -  
- .  
1500 — 1000 ,  
: ,  
- ;  
- .  
: — ,  
• 50 500 :  
• 100 500  
• 1000 1500 :  
• — ,  
: ,  
- .  
- .  
- 4.1.4. [2];  
4.2.3 ( . — ).  
( , \*  
, ) , , -  
4.2.4 [2]. -  
, , -  
, -  
• , [2]. -  
4.2.5 :  
• :  
5



( )

1

.1

1

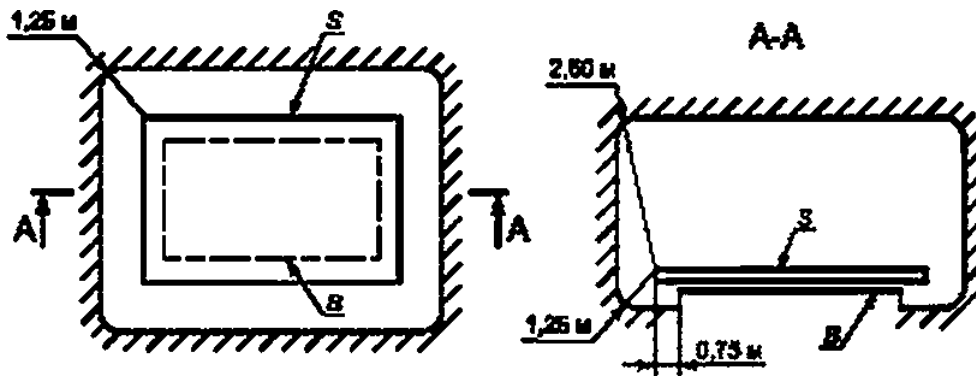

S—

S.  
S; 0.75; 1.26; 2.50 —

2.6

S

1

12.1.019—2017

( )

.1.

.1

12.2.007 0			
0			0 1 61140 [3] -
1	— .	-	-
II		-	,
III		-	

I , - ,  
I , -  
II , -  
111 , -  
III , -  
- , -  
-  
.

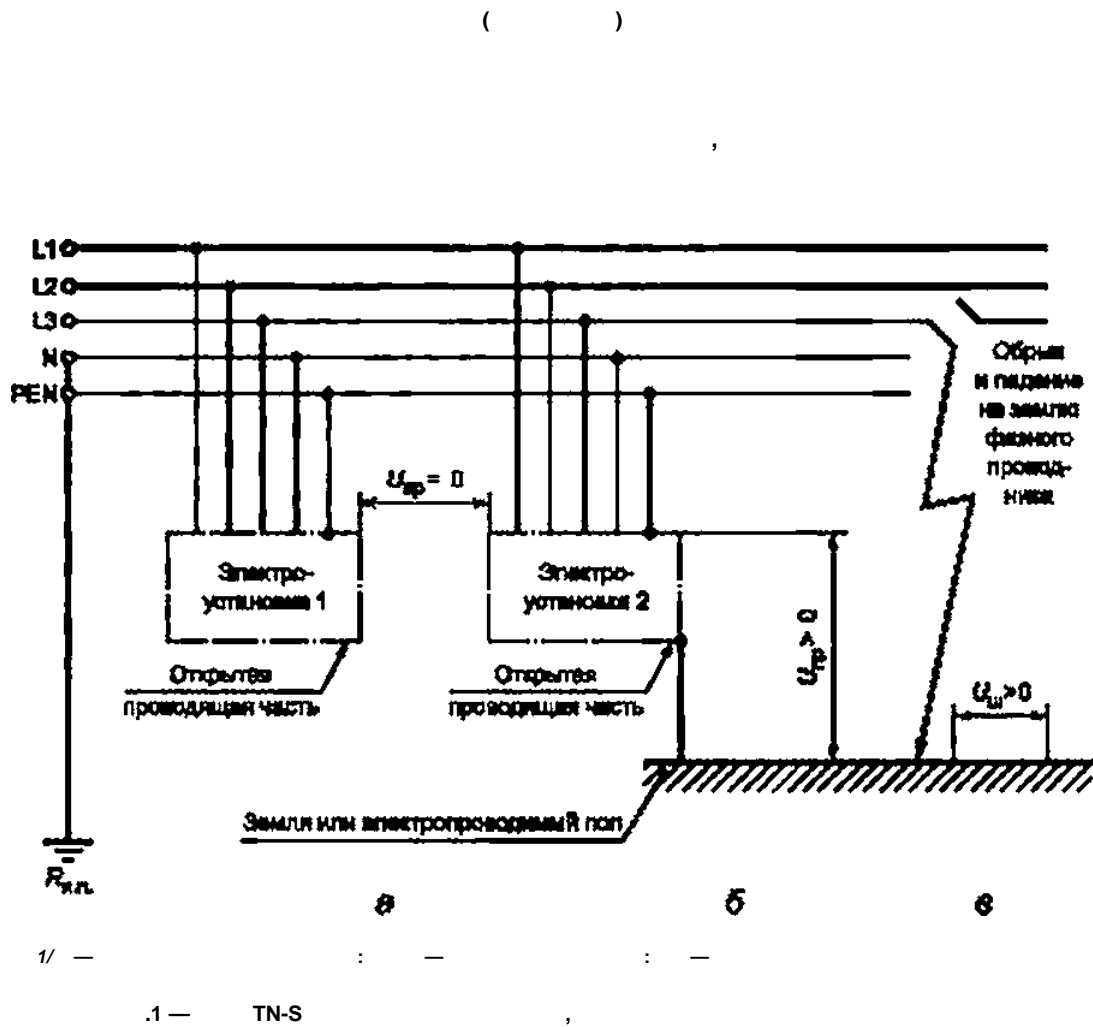

6

12.1.019—2017

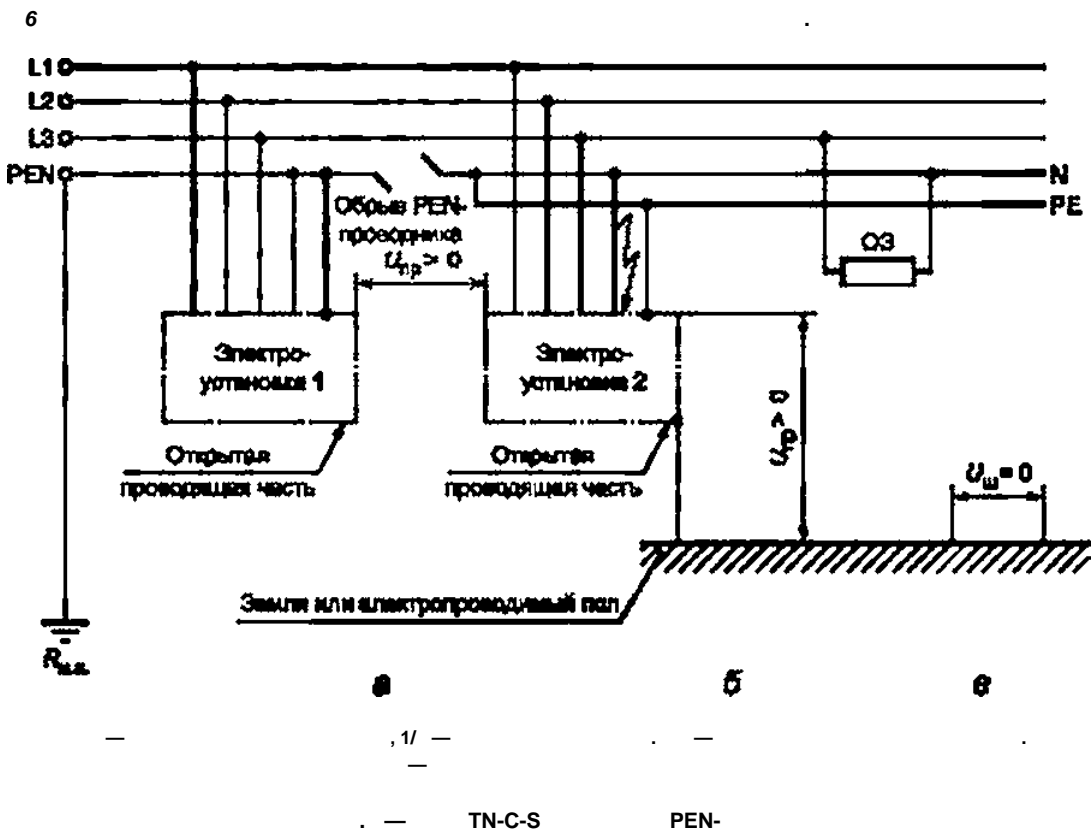
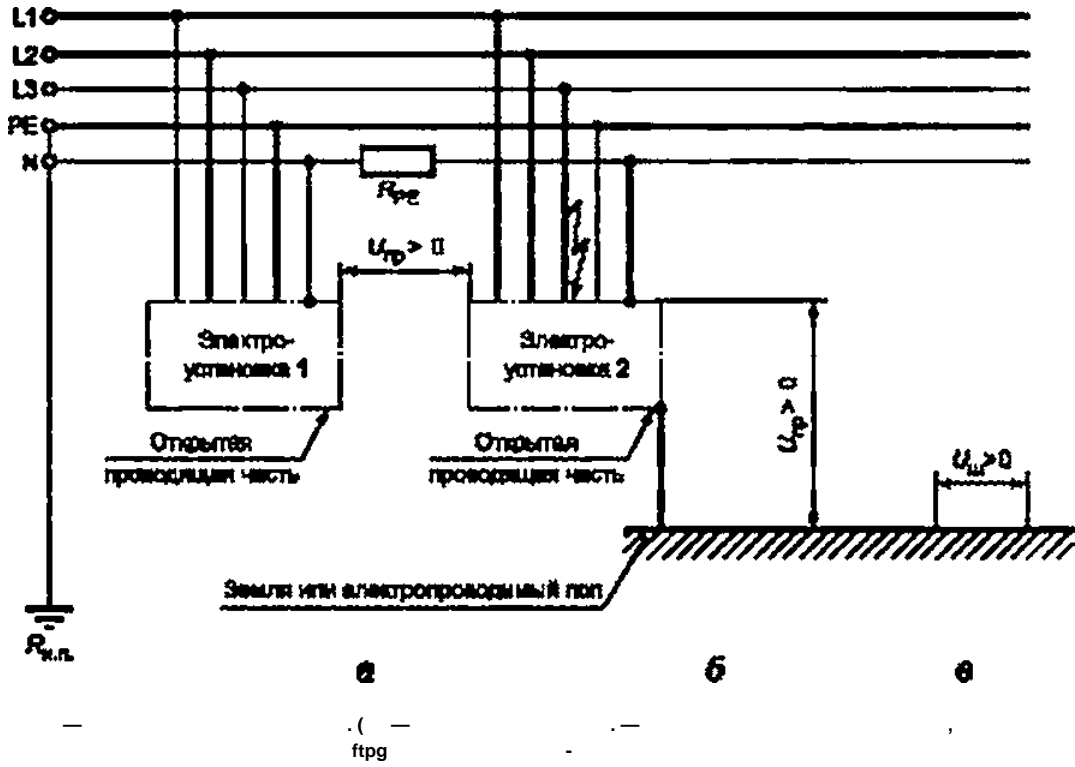

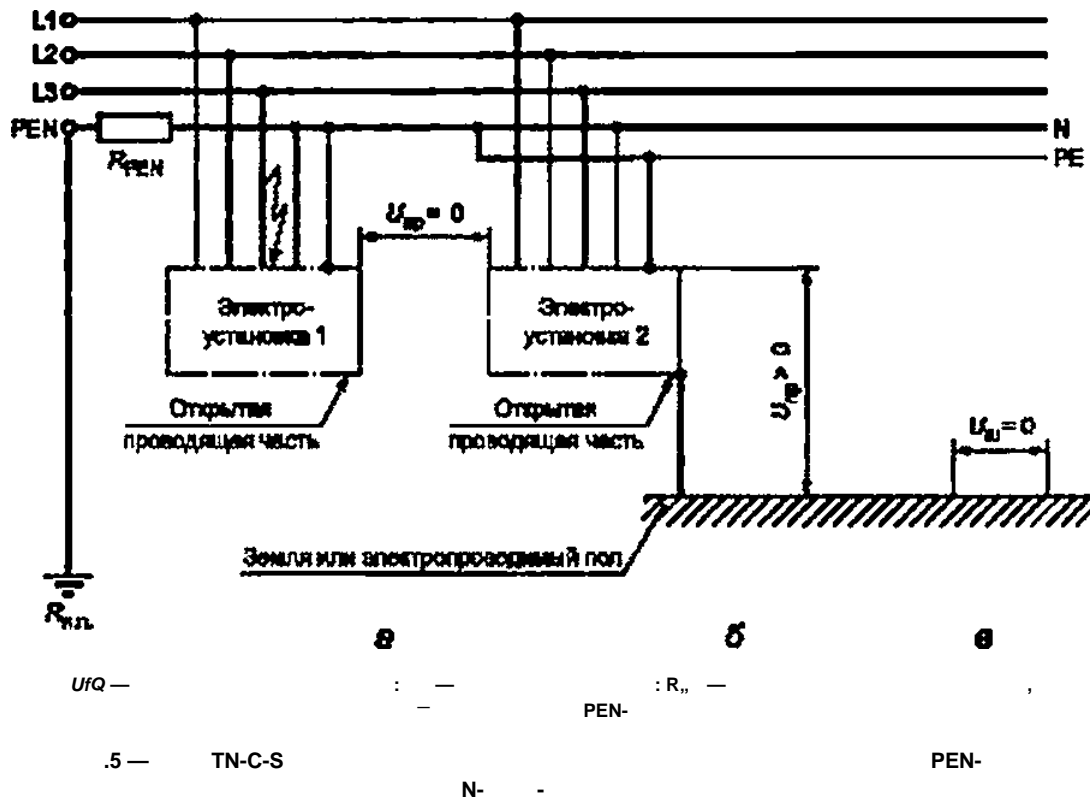
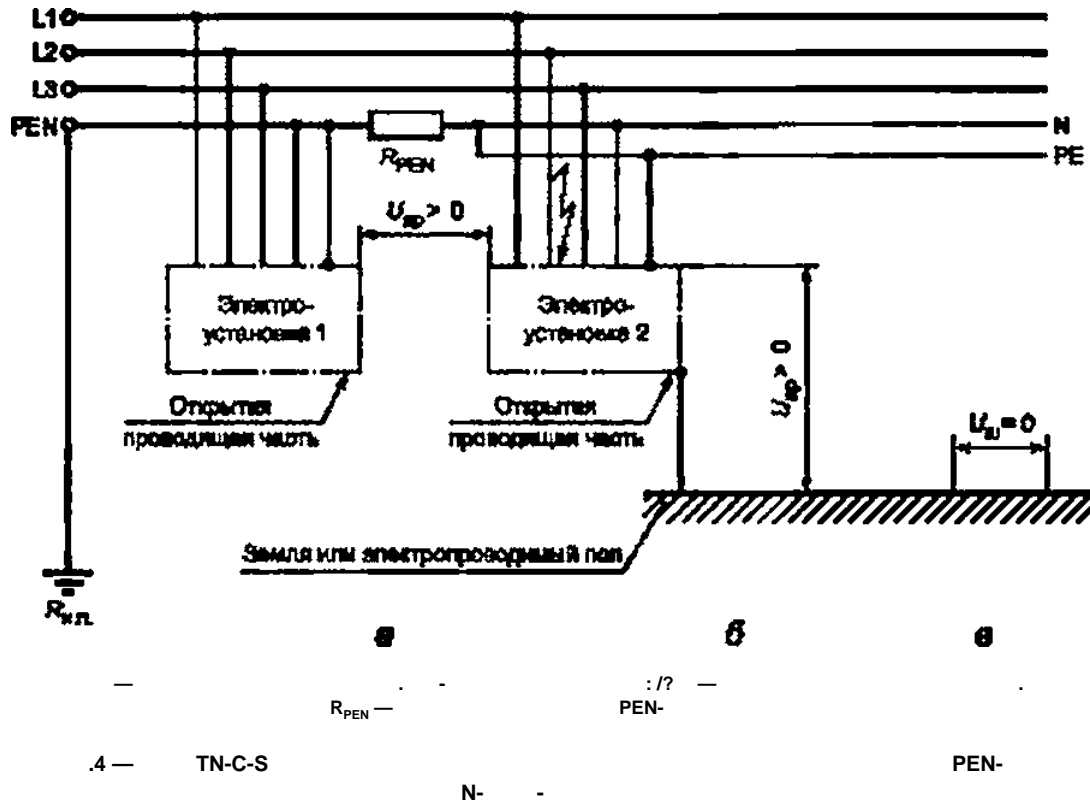



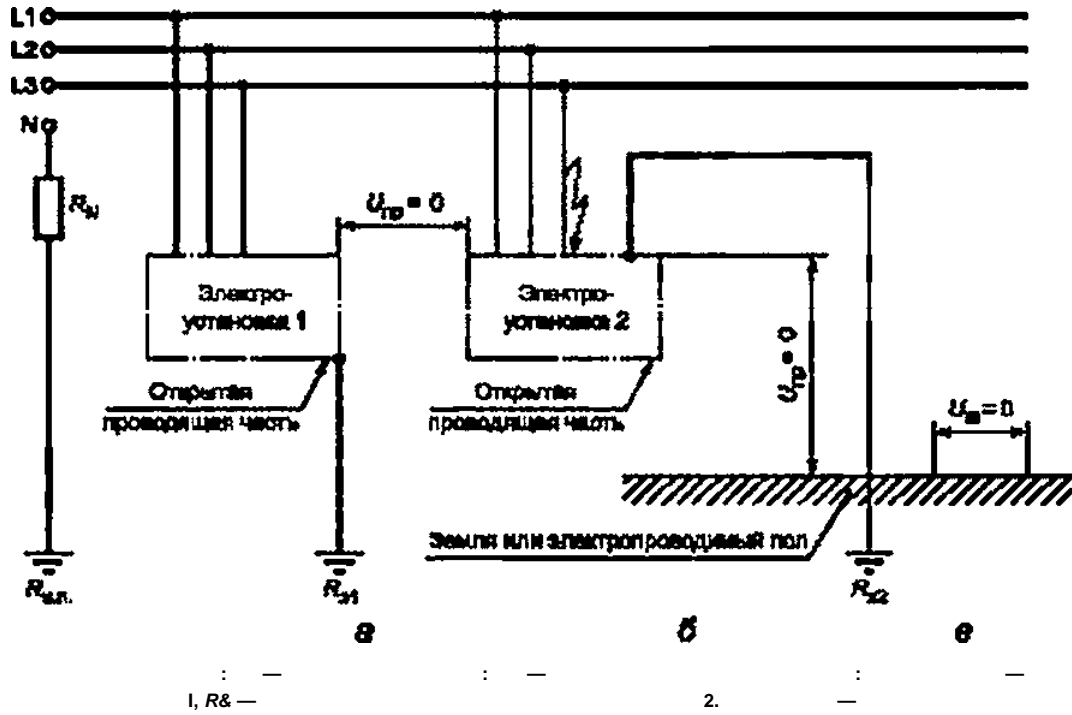

.8 — IT

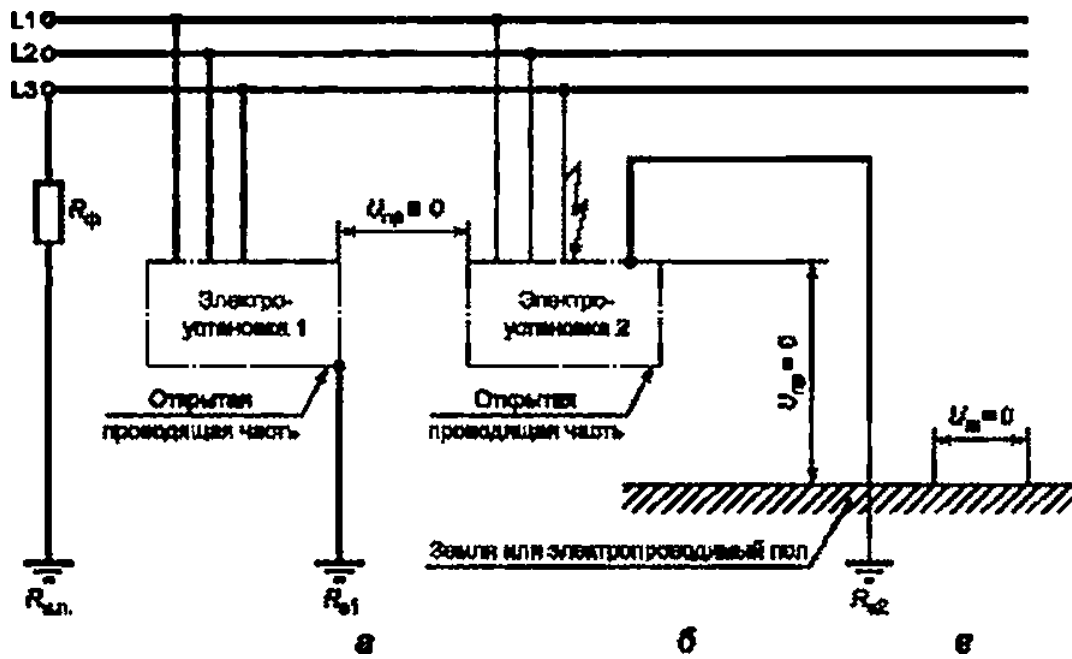

.9 — IT

12.1.019—2017

( )

.1

.1.

.1

	( )	( )
-		
-	: - ( ) : - : - ; -	, ( ) ): : • • - - • PEN- -
-		-
-	—	
-	—	
-		

.2

.2.

.2

-		-	-
-			
( )			
-		:	( )
-		•	-
-		•	-
( )		•	-
			•

. 2

»			
-	-		
<p>1</p> <ul style="list-style-type: none"> <li>•</li> <li>•</li> <li>-</li> </ul>	<p>1</p> <p>•</p>		

12.1.019—2017

[11 60050-195—2005

[21

19 2

[31

004/2011

9 2011 . № 878)

16 2011 . 768)

658.3:331.45:006.354

13.260

8—2017/59

08.11.2018.

11.12.2018.

60\*84<sup>1</sup>/g.

. . . 2,32. -

. . . 2.10.

56 . . 1013.

« . 117418 ,  
www.gostinfo.ru info@gostinfo.ru

- . . 31. . 2.